

TECHNICAL INFORMATION | TRACK-MOUNTED JAW CRUSHERS

MOBICAT MC 120(i) PRO

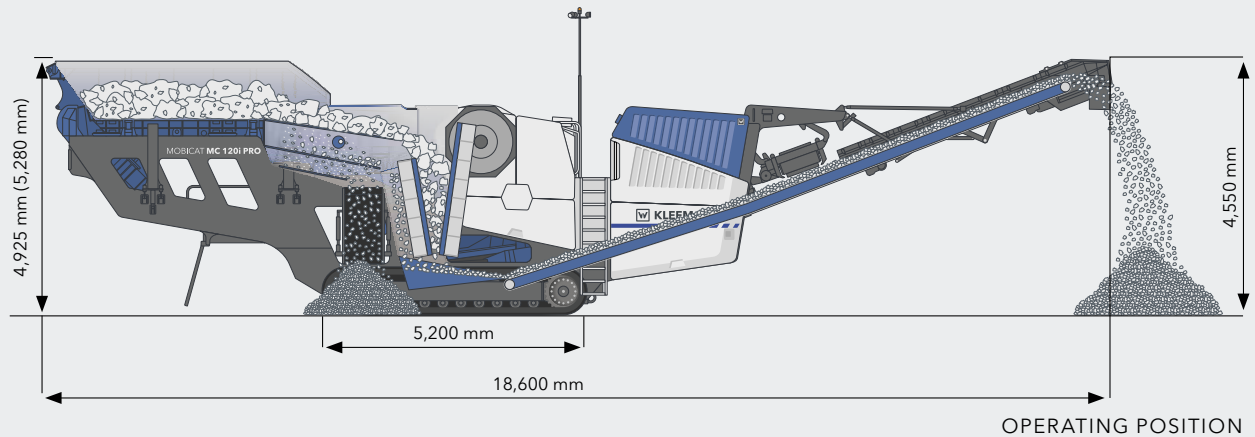



TECHNICAL HIGHLIGHTS

- ☒ Extremely robust design
- ☒ Very high production outputs, low-maintenance operation
- ☒ Crusher unblocking system via frequency converter (optional)
- ☒ External power supply (optional)
- ☒ Optimal combination with downstream cone crusher MOBICONE MCO 11 PRO
- ☒ Optional crusher extractor channel

TECHNICAL INFORMATION MC 120(i) PRO

Feeding unit

Feed capacity up to approx. (t/h) ¹⁾	650
Max. feed size (mm)	1080 x 680
Feed height for rear feeding (mm)	4,930
Width x Length (with extension) (mm)	2,850 x 4,100 (3,900 x 3,910)
Hopper volume (with extension) (m ³)	9.7 (13)

Vibrating feeder

Width x Length (mm)	1,100 x 3,600
---------------------	---------------

Prescreening

Type	Double-deck heavy-piece screen
Width x Length (mm)	1,200 x 2,900

Side discharge conveyor (optional)²⁾

Width x Length (mm)	650 x 6,650
Discharge height approx. (mm)	3,450

Crusher

Single toggle jaw crusher type	STR 120
Crusher inlet width x depth (mm)	1,200 x 800
Crusher weight approx. (kg)	30,000
Crusher drive type, approx. (kW)	electric, 200
Adjustment range of gap width (mm) ³⁾	70 - 200
Gap adjustment	fully hydraulic

Crushing capacity^{1) 3)}

Crushing capacity with CSS = 100 mm up to approx. (t/h)	250
Crushing capacity with CSS = 130 mm up to approx. (t/h)	325
Crushing capacity with CSS = 160 mm up to approx. (t/h)	400

Discharge chute(optional)

Width x Length (mm)	1,300 x 2,000
---------------------	---------------

Crusher discharge conveyor

Width x Length (extended) (mm)	1,200 x 12,300 (13,900)
Discharge height approx. (extended) (mm)	4,000 (4,550)

Power supply unit

Drive concept	diesel-electric
Drive output of Scania diesel engine (kW)	368 - 410 ⁴⁾
Generator (kVA)	500

Transport

Transport height approx. (mm)	4,100
Transport length approx. (mm)	18,700
Max. transport width (mm)	3,000
Transport weight of basic plant - max. configuration (kg)	72,500 - 85,500

¹⁾ dependent on the type and composition of the feed material, the feed size, the prescreening, as well as the desired final grain size

²⁾ foldable side discharge conveyor remains attached to the plant for transportation

³⁾ for hard stone, CSS = Close Side Setting

⁴⁾ depending on the respective exhaust emission standard



MOBICAT MC 120(i) PRO

The MOBICAT MC 120(i) PRO, the first jaw crusher in the PRO line, is used for precrushing almost all types of natural stone. The jaw crusher is extremely robust and impresses with its low-maintenance operation. The machine therefore guarantees high production outputs.

STANDARD EQUIPMENT

- Hydraulically foldable feed hopper
- Frequency-controlled vibrating feeder, frequency-controlled prescreen. Automatic control in relation to crusher filling level thanks to CFS
- Jaw crusher with crusher jaws made from manganese-high carbon steel

OPTIONS



- Hopper replacement elements: KRS Kleemann Resistant Steel and plastic elements
- Hopper extension, rear filling width 3.8 m
- Side discharge conveyor, can be folded hydraulically or fixed: can be used on both sides, discharge height 3,300 mm, foldable version can remain on the plant for transportation, incl. spray system
- Different prescreen coverings available for upper and lower decks: punched plate, slotted grate, wire cloth
- Crusher extractor channel: additional protection of crusher discharge conveyor in the case of coarse rock with sharp edges
- Extended crusher discharge conveyor, can be folded hydraulically
- Belt scale in crusher discharge conveyor
- Belt cover for crusher discharge conveyor
- Electromagnetic separator, permanent magnetic separator, magnet preparation
- External power supply for efficient mains operation
- Automatic lubrication of crusher bearings
- Platforms: prescreen platform to the right, platform above the crusher
- SPECTIVE control concept: menu-guided user interface, 12" control panel, lockable control cabinet, protected against dust and vibrations; WITOS FleetView telematics system for efficient fleet and service management
- Remote control: Cable and radio remote control incl. shutdown function for feeding unit
- Water spray system for dust reduction
- Lighting
- Line coupling for interlinking with other KLEEMANN plants
- Crusher unblocking system via frequency converter: start-up with full crusher, adjustable crusher speed, crusher can be moved in reverse
- Rock chisel: for loosening material that is stuck or crushing pieces of rock within the entire feed area; remains on the plant for transportation; incl. platform and remote control
- Diesel refuelling pump: hose system incl. pump, possible to refuel from separate tank
- Camera system for monitoring feeding unit and crusher from the ground, also available with wireless expansion
- Sockets: 125 A socket supply for operation of additional electrical equipment (e.g. stockpile conveyor, screening plant MS EVO); 16 A/32 A power supply for supplying service equipment
- Track pads for crawler tracks to protect the ground
- Premium lighting
- Climate packages: hot and cold package



SPARE PARTS

Efficient operation of the machine also requires the selection of the right wear parts. The KLEEMANN original parts are optimally designed for the requirements of users and the machine. They are characterised by a long service life, excellent quality, good availability and simple assembly. With application know-how and expertise and competent advice, we help our customers to find the optimal wear part for their individual application.

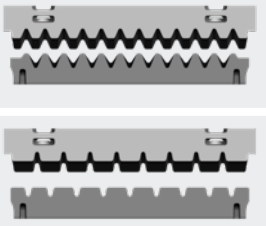
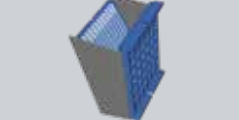
APPLICATION-DEPENDENT WEAR PARTS

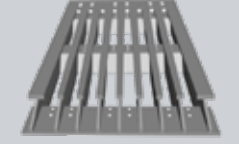
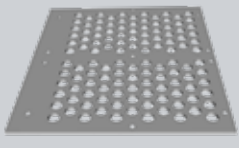
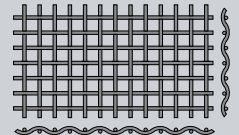
<p>Crusher jaws</p> <p>RT (regular teeth)</p> <p>FT (flat teeth)</p>		<ul style="list-style-type: none"> ☑ Well-balanced in terms of service life, energy requirement and crushing pressure ☑ Suitable for natural stone and gravel
<p>Lateral wedges</p>		<ul style="list-style-type: none"> ☑ To protect the crusher housing against wear ☑ Practical design of lateral wedges makes possible quick assembly ☑ Lateral wedges together with the crusher jaw form an optimal crushing chamber for material crushing
<p>Conveyor belts</p>		<ul style="list-style-type: none"> ☑ Endless, closed, multi-layered conveyor belts are suitable for all requirements and increase the conveying capacity of the plants ☑ Full-rubber edges guarantee optimum material transport ☑ Resilient rubber intermediate links dampen impacts of different materials
<p>Slotted grates</p>		<ul style="list-style-type: none"> ☑ Easing of burden on crusher with prescreening of fines ☑ Flexible prescreening possible with simple exchange of entire slotted grate ☑ Expansion of gap width in direction of material flow guarantees efficient screening capacity in the long run ☑ Available in different sizes
<p>Punched plates</p>		<ul style="list-style-type: none"> ☑ Relieve load on the crusher through prescreening of the fines ☑ Excellent separation results thanks to offset arrangement of round holes ☑ Flexible prescreening possible with simple exchange of punched plates ☑ Avoidance of laminated grain in the product ☑ Available in different sizes
<p>Screen surfaces</p>		<ul style="list-style-type: none"> ☑ Screen surfaces available in different mesh shapes, wire qualities and thicknesses: <ul style="list-style-type: none"> > Square mesh > Rectangular mesh > Harp screens (G-harp, W-harp, S-harp, Varia harp)

More information can be found online at www.partsandmore.net or in our Parts and more catalogue